

Location: _____



FS1930-FL

12" x 12" x 8" STAINLESS STEEL FLOOR AREA AND INDIRECT SANITARY WASTE DRAIN WITH FLANGE

Specification: MIFAB Series FS1930-FL, 12" x 12" x 8" deep 16 gauge, All Type 304 (CF8) stainless steel sanitary floor area and indirect waste drain complete with cast stainless steel secured rim and grate with allen key vandal proof stainless steel screws, stainless steel anchor flange with weepholes and anti-splash dome strainer.

Function: Used in kitchens, restaurants, breweries, dairies, creameries, food processing locations, nuclear, gas and coal fired power stations, chemical plants, laboratories and other areas where the corrosion resistance of Type 304 stainless steel is required for superior sanitation. The anchor flange is designed to receive water proofing membrane. A membrane clamp (Suffix -C) is recommended to secure the water proofing membrane to the anchor flange.

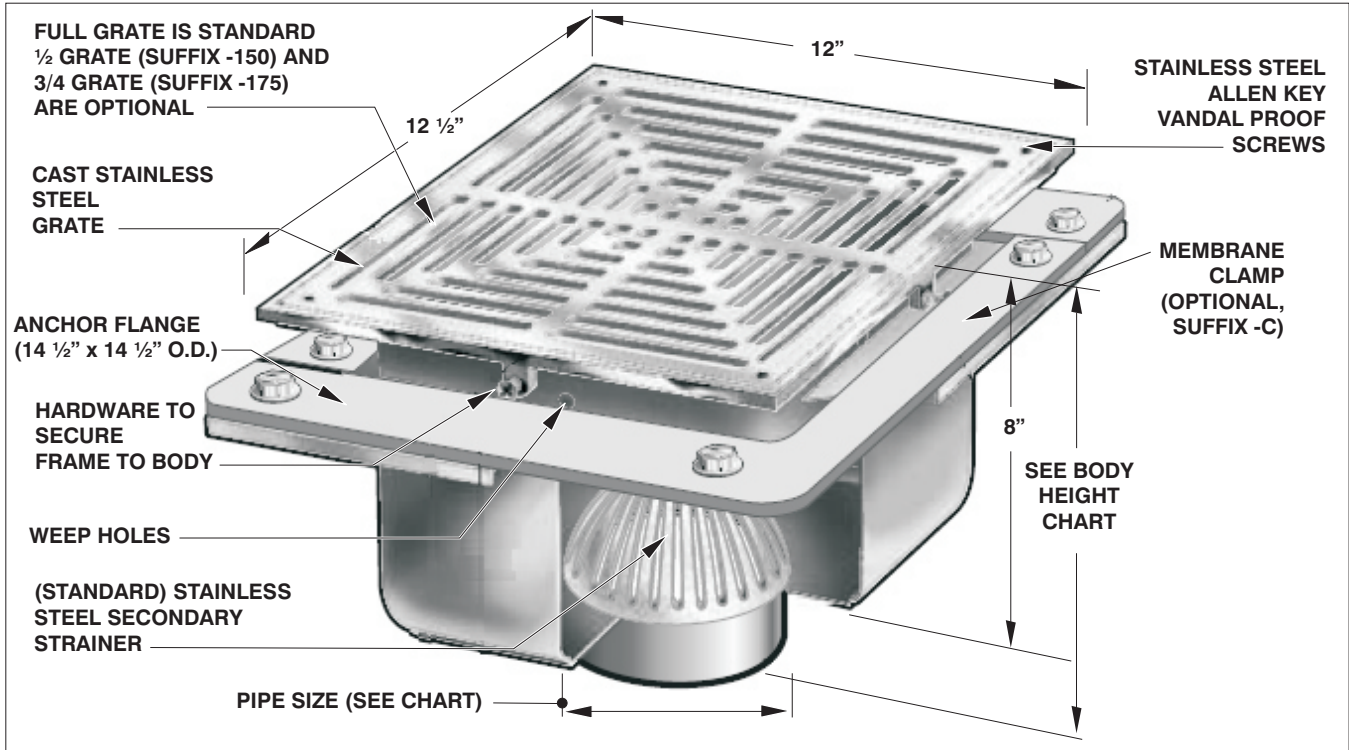

PIPE SIZE	BODY HEIGHT				
	NO HUB (STANDARD)	PUSH ON (P)	THREADED (T)	INSIDE CAULK (X)	PVC/ABS (-30)/(-31)
2" (51)	10 5/8" (270)	11 1/8" (283)	10 1/8" (257)	10 5/8" (270)	11 5/8" (295)
3" (76)	10 5/8" (270)	11 1/8" (283)	10 1/2" (267)	10 5/8" (270)	11 5/8" (295)
4" (102)	10 5/8" (270)	11 1/8" (283)	10 1/2" (267)	10 5/8" (270)	11 5/8" (295)

SUFFIX	OPTIONAL VARIATIONS:	SUFFIX		SUFFIX	
-1	Nickel bronze frame and grate	-32	Deep seal trap with flushing connection	(Standard)	No hub outlet
-3	Stainless steel frame and grate (standard)	-51	2 1/2" round center hole in grate (-1, -3 only)	-C	Membrane clamp with hardware
-5	Sediment bucket	-83	Stainless steel mesh screen over sediment bucket	-F4	4" round funnel
-6	Security screws (H-1039A)	-90	Threaded side outlet	-F6	6" round funnel
-7	1/2" trap seal primer connection	-90NH	No hub side outlet	-G	4" x 9" oval funnel
-8	Backwater valve	-95	Client logo (-1, -3 only)	-J	3" x 1" oval funnel
-9	Hinged grate	-150	1/2" grate	P	Push on outlet
-21	Secondary flat stainless steel strainer	-175	3/4" grate	-PA	Pennsylvania Steel Act compliant product
-22	Less grate	-BA	Buy American Act compliant product	T	Threaded outlet
-30	PVC outlet			X	Inside caulk outlet
-31	ABS outlet			-Z	Extended wide elastomeric flange (with -FL only)

Job Name: _____ Page No: _____
 Section No: _____ Contractor: _____
 Schedule No: _____ Purchase Order No: _____